

H

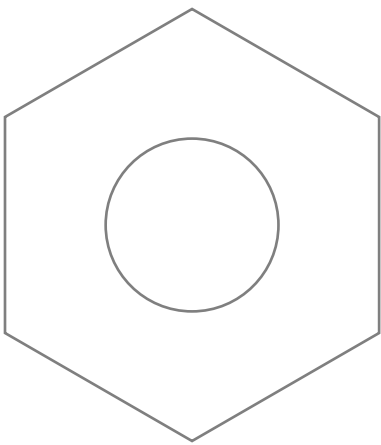

C2

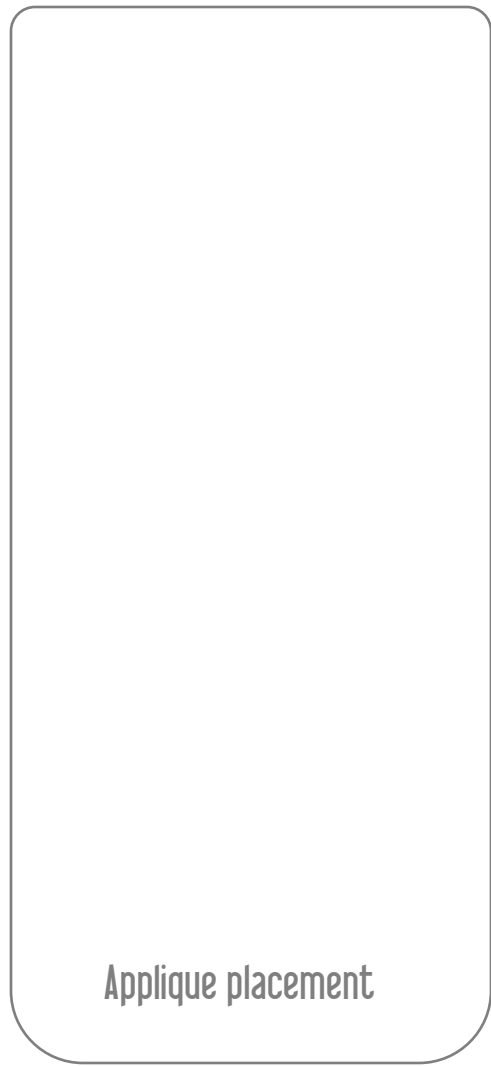

F1

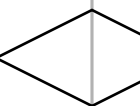

Bag Bottom
Cut 2 of main fabric
Cut 2 of lining fabric
5/8" seam allowance

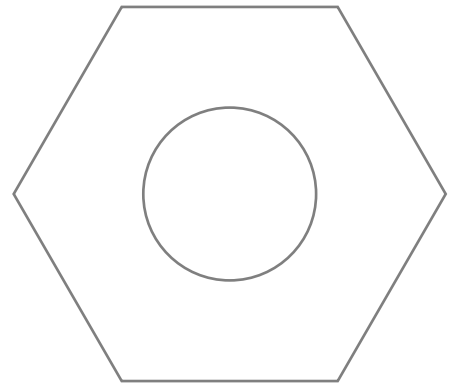
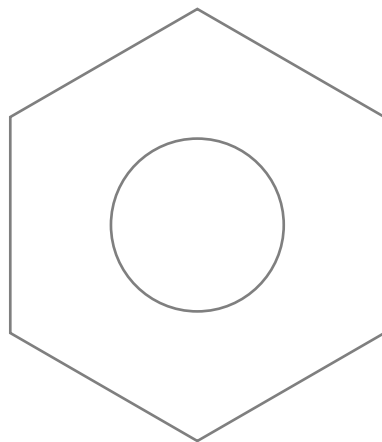
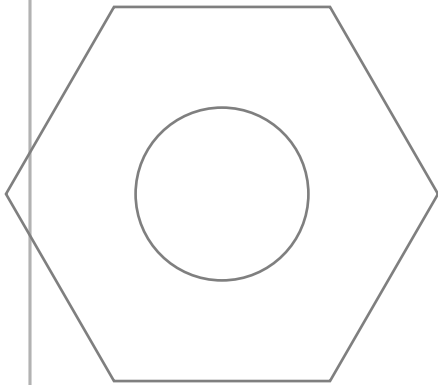

Opening for turning
(lining only)

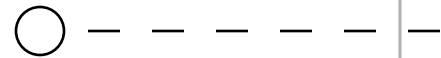

Bot Bag
Pg. 6/9

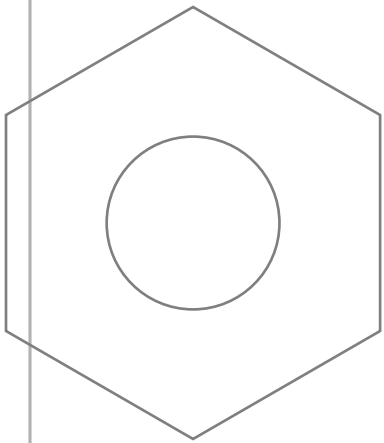

Opening for turning



E2

J1

G2

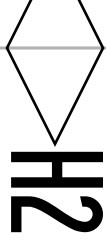

Robot Shoulder

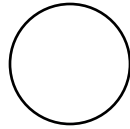

Applique
Cut 2

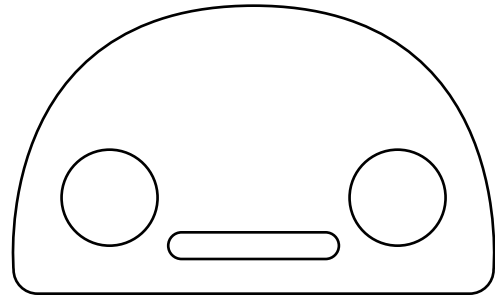

Robot Head Applique
Cut 1

Robot Arms

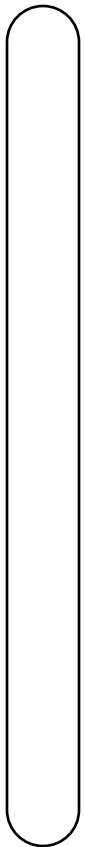

Applique
Cut 2

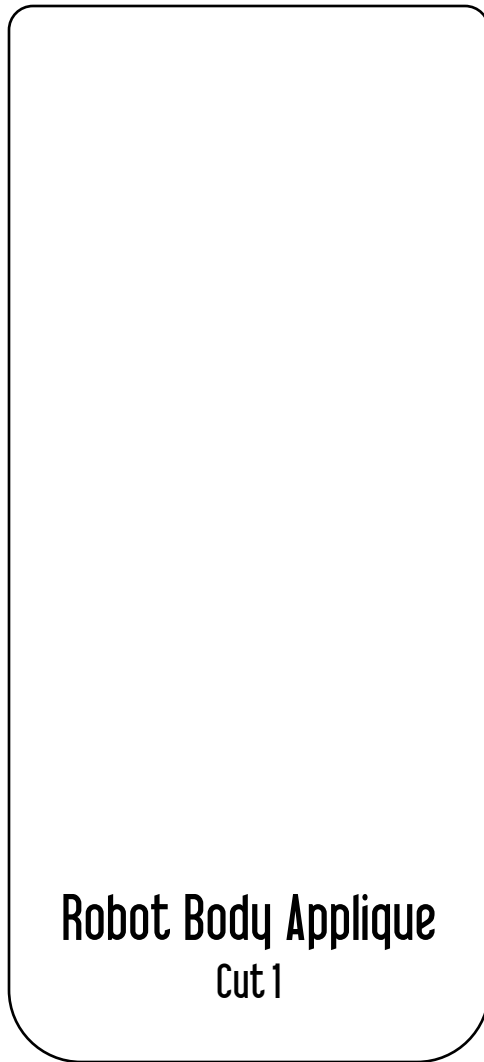

Robot Body Applique
Cut 1

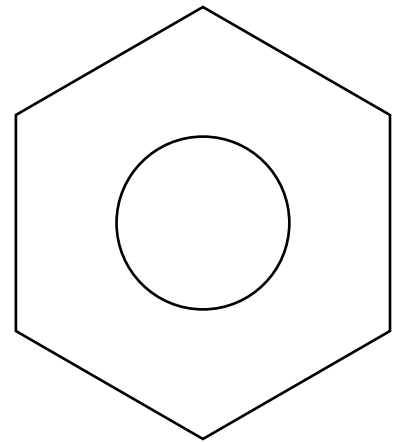

Bolt Applique
Cut 5

Robot Legs Applique

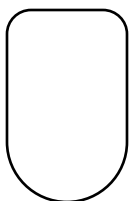

Cut 2

K1

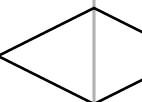



12

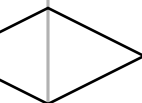
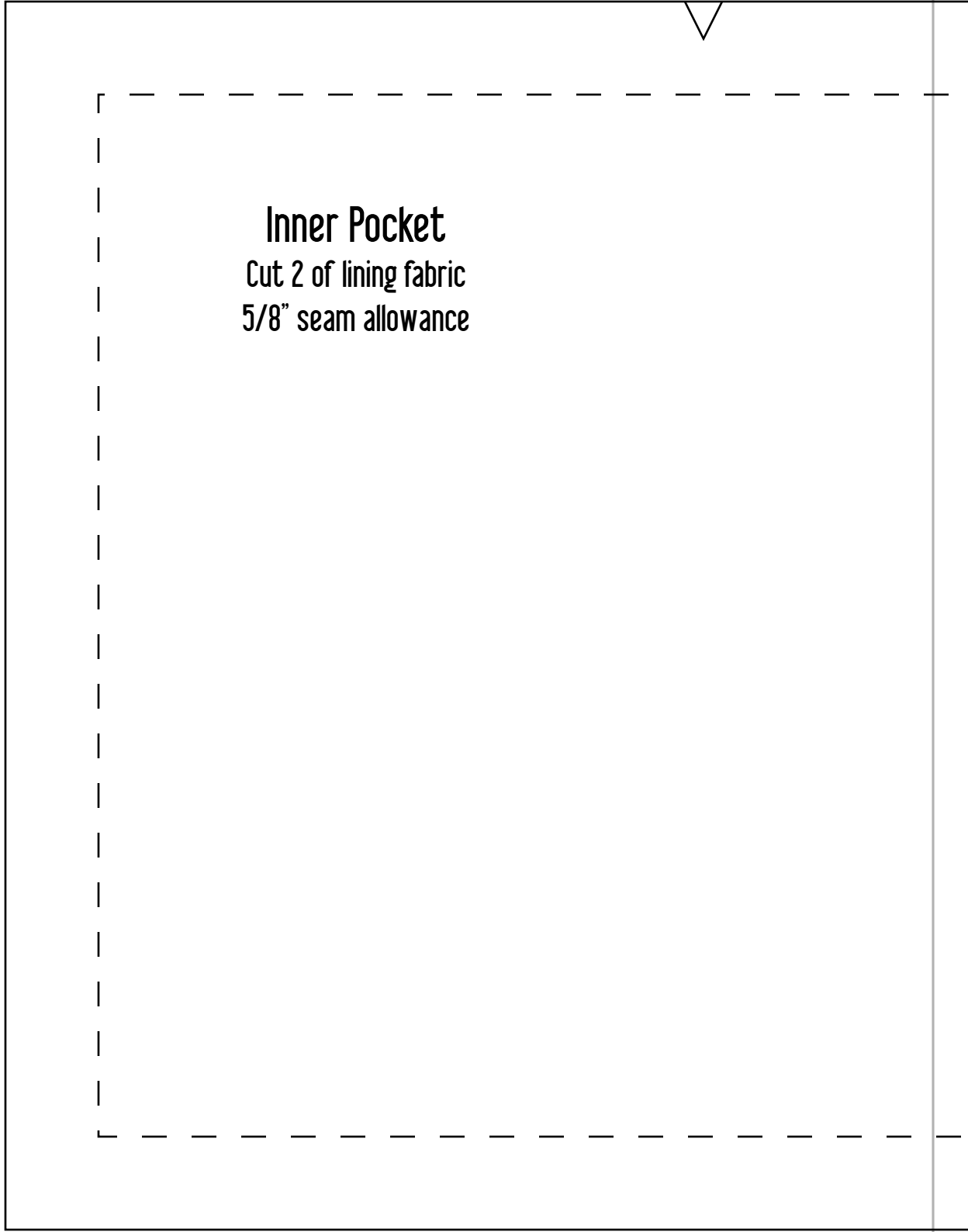

K2

Bot Bag
Pg. 8/9

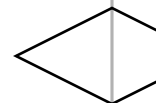
L1 

L2

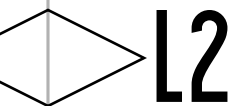
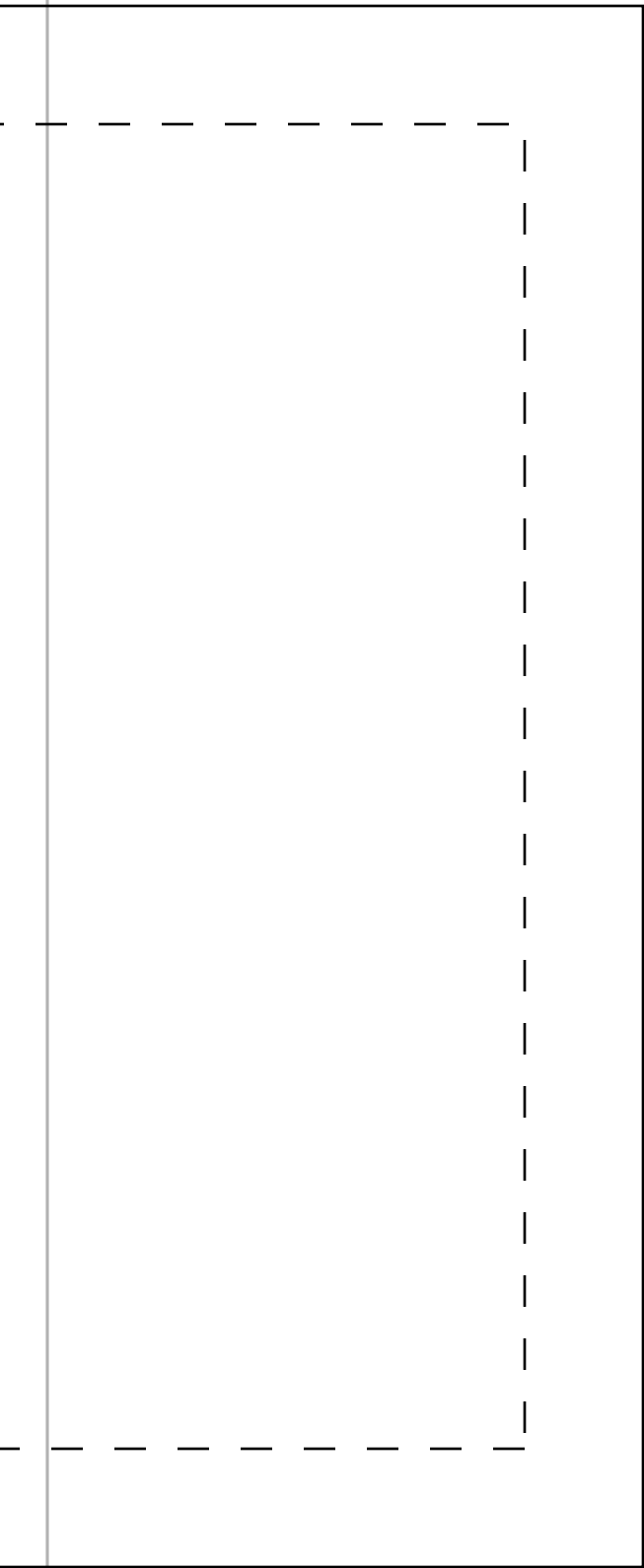
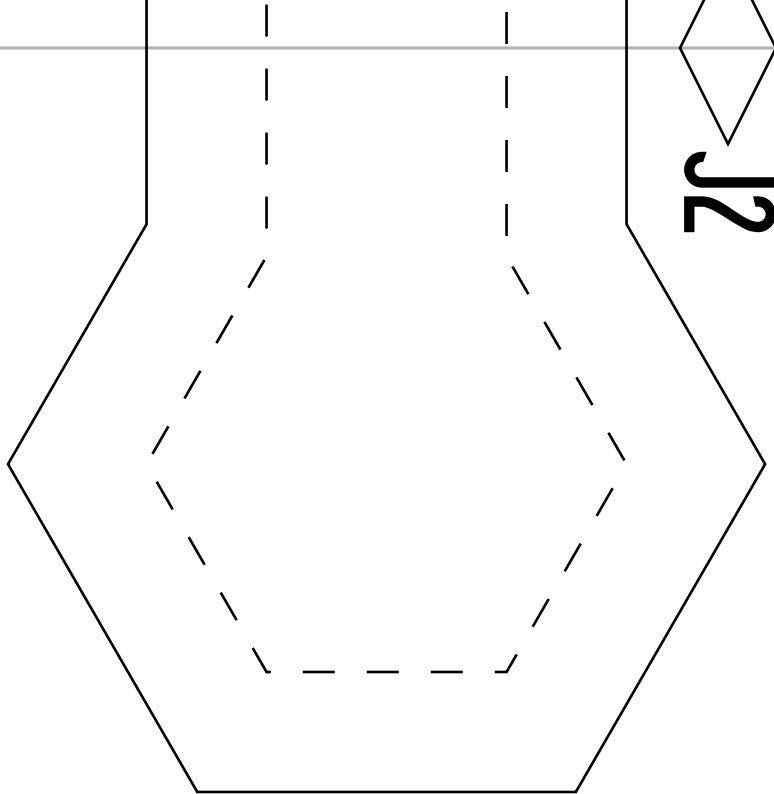

L2