

Bag Front & Back

Cut 2 of main fabric

Cut 2 of lining fabric

5/8" seam allowance

A1

C1

A2

B1

Paint/applique placement

Zipper placement

Raven Hobo Bag
Pg. 2/9

D1

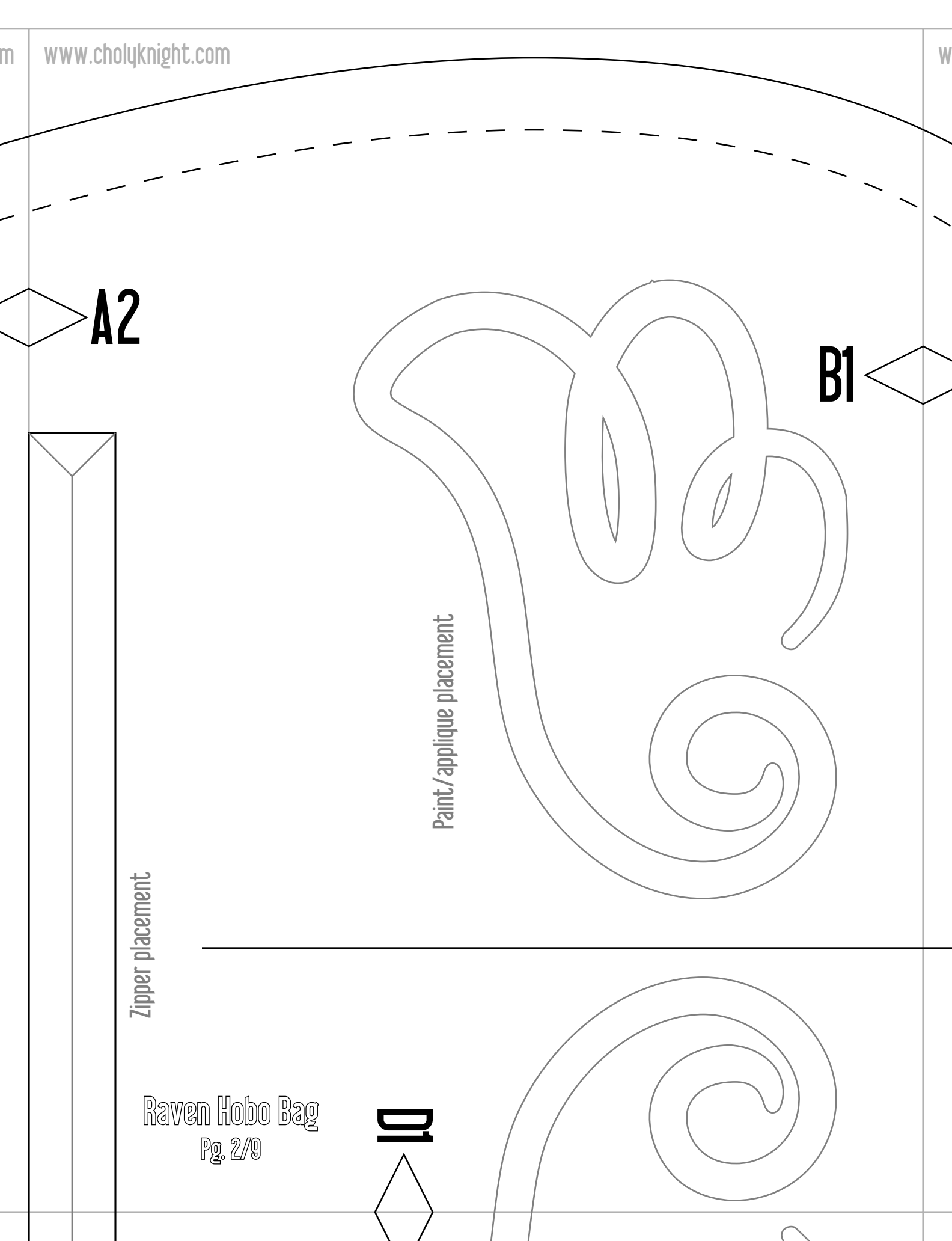

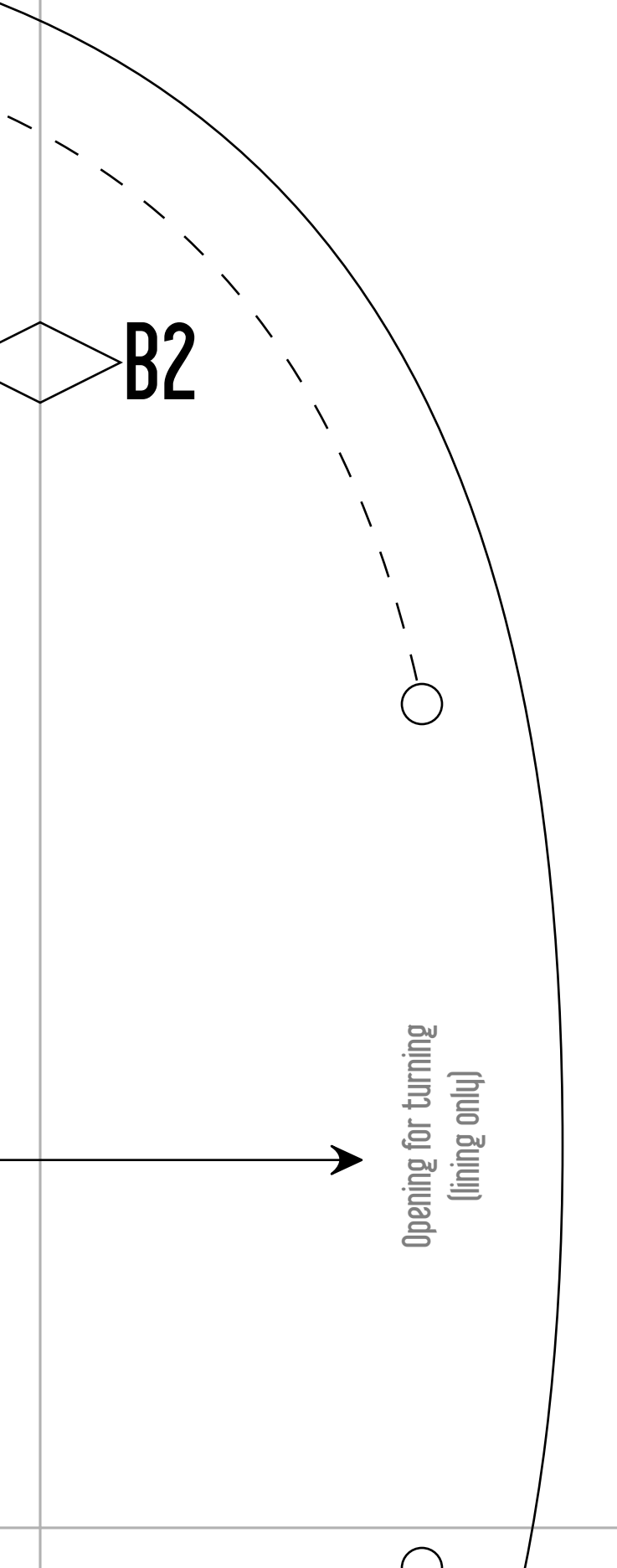

B2

Opening for turning
(lining only)

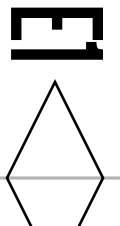
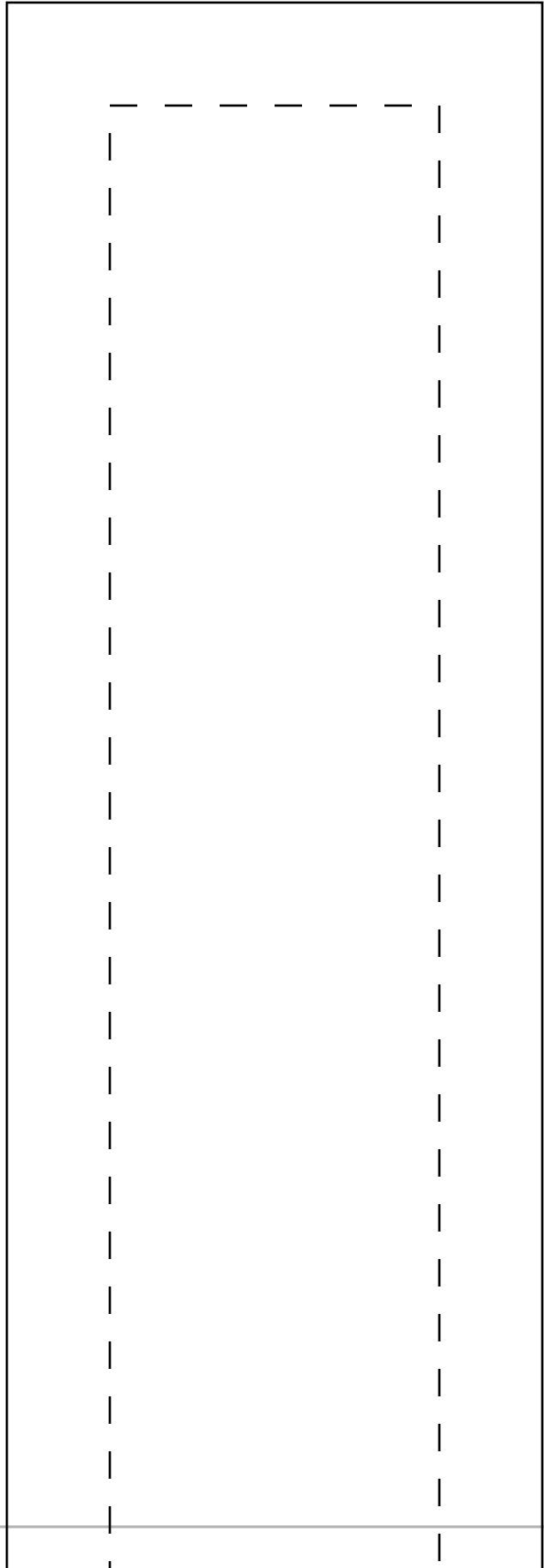

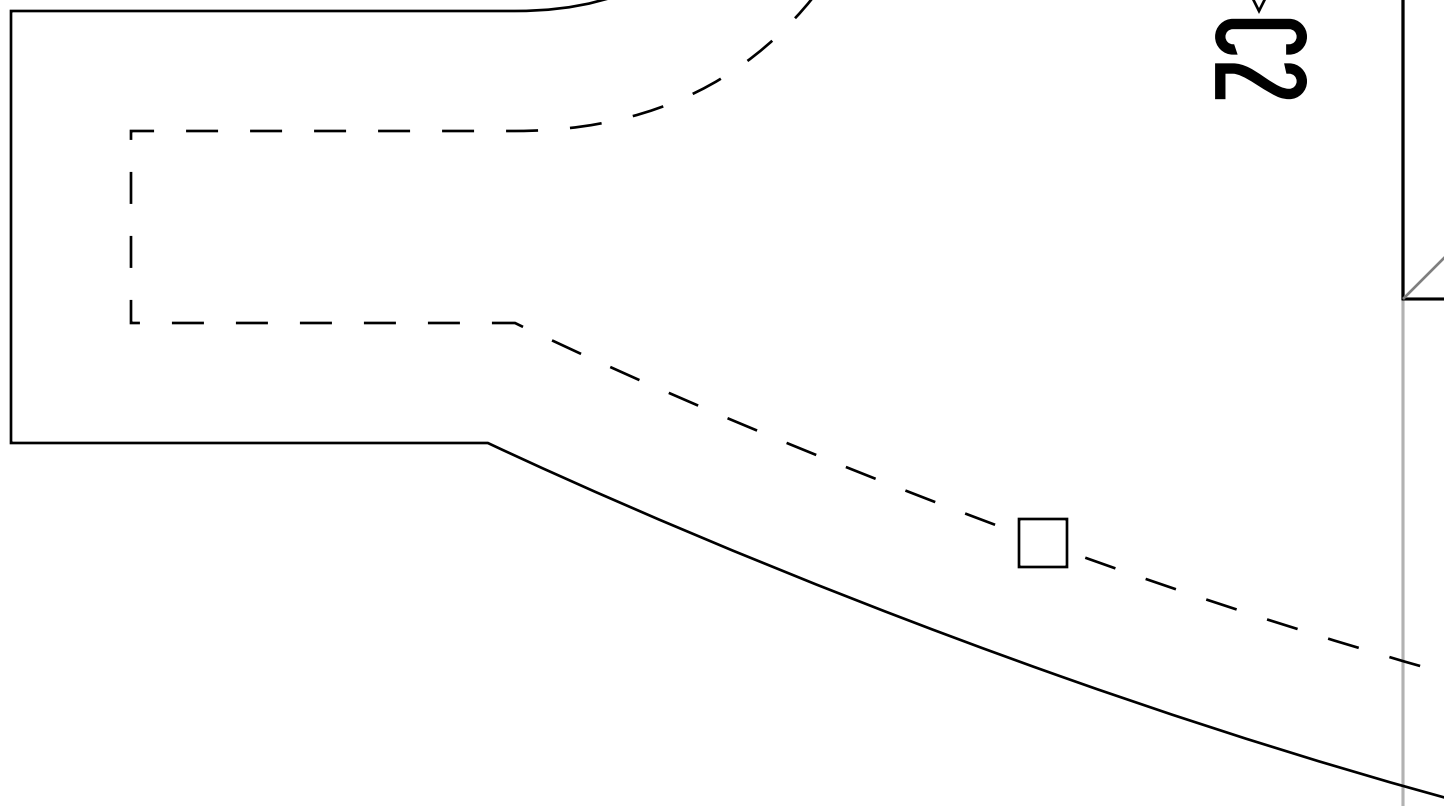

Raven Hobo Bag
Pg. 4/9

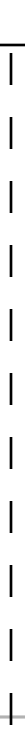
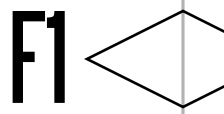

Bag Sides

Cut 1 on fold of contrast fabric
Cut 1 on fold of lining fabric
5/8" seam allowance

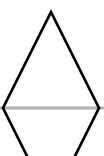

Raven Hobo Bag
Pg. 5/9

D2

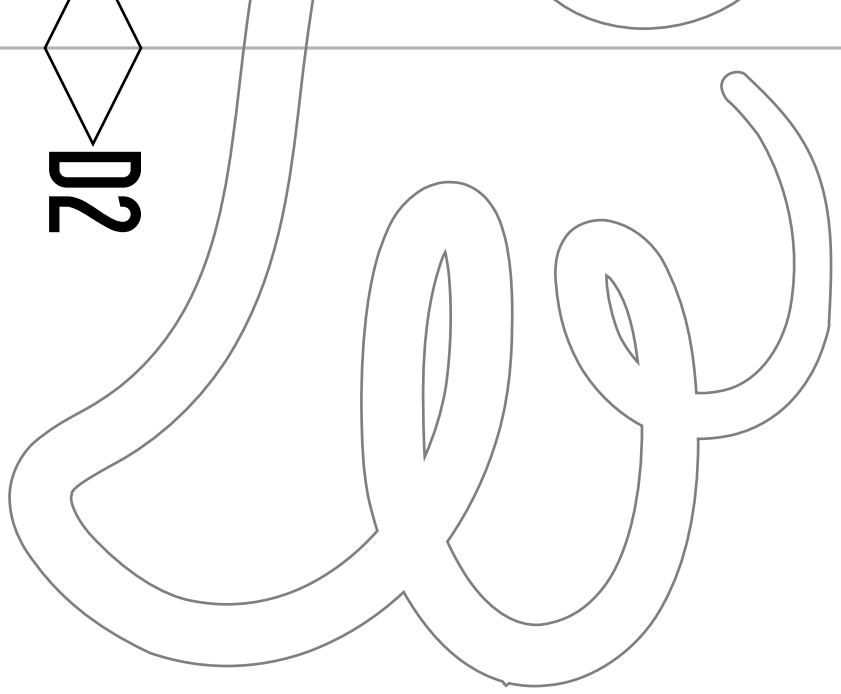

F2

G1

H1

E2

J1

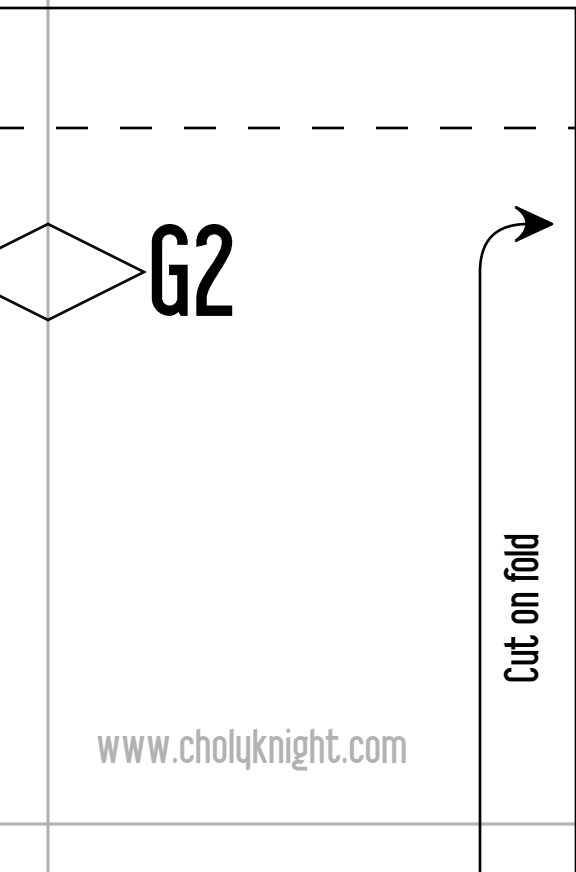
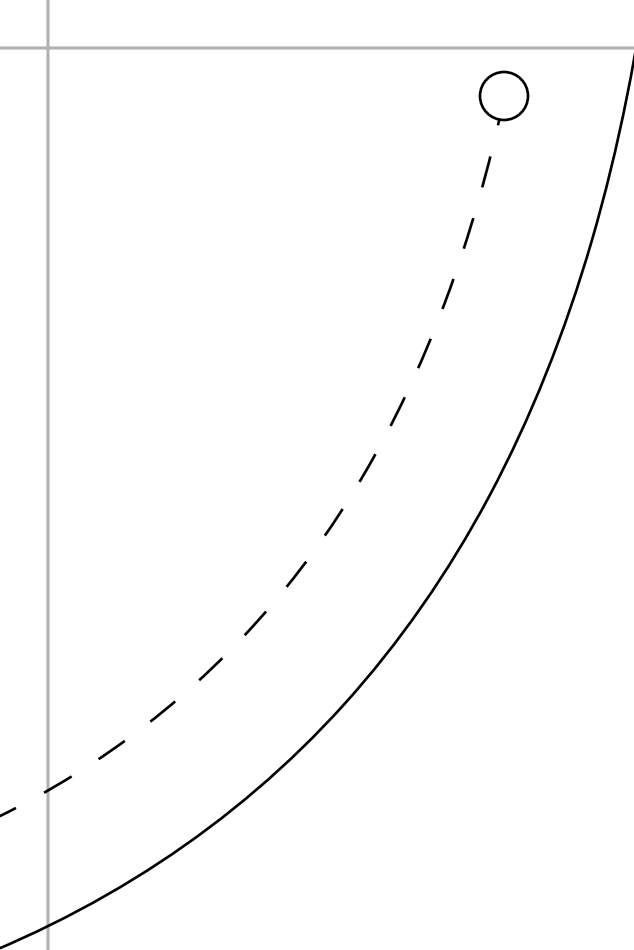

Raven Hobo Bag
Pg. 6/9

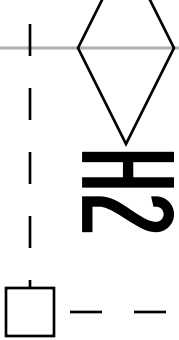

Wing Applique/Template
Cut 2

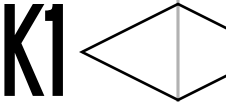
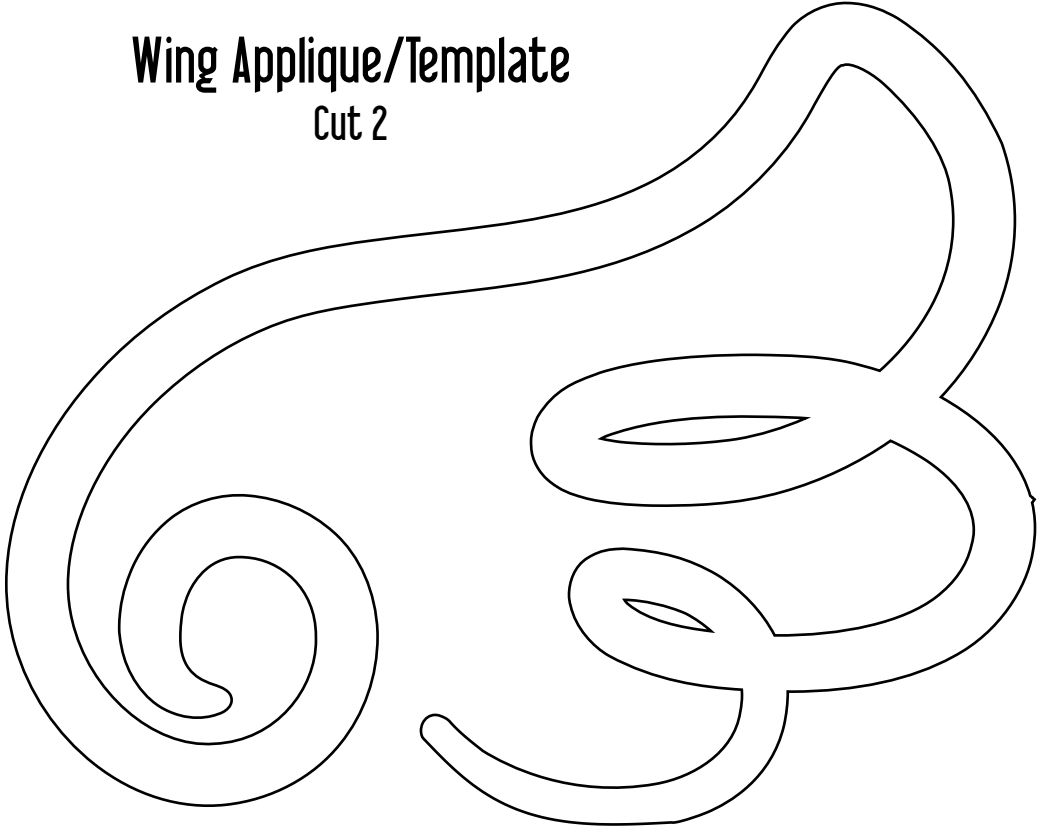

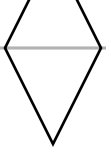

12

www.cholyknight.com

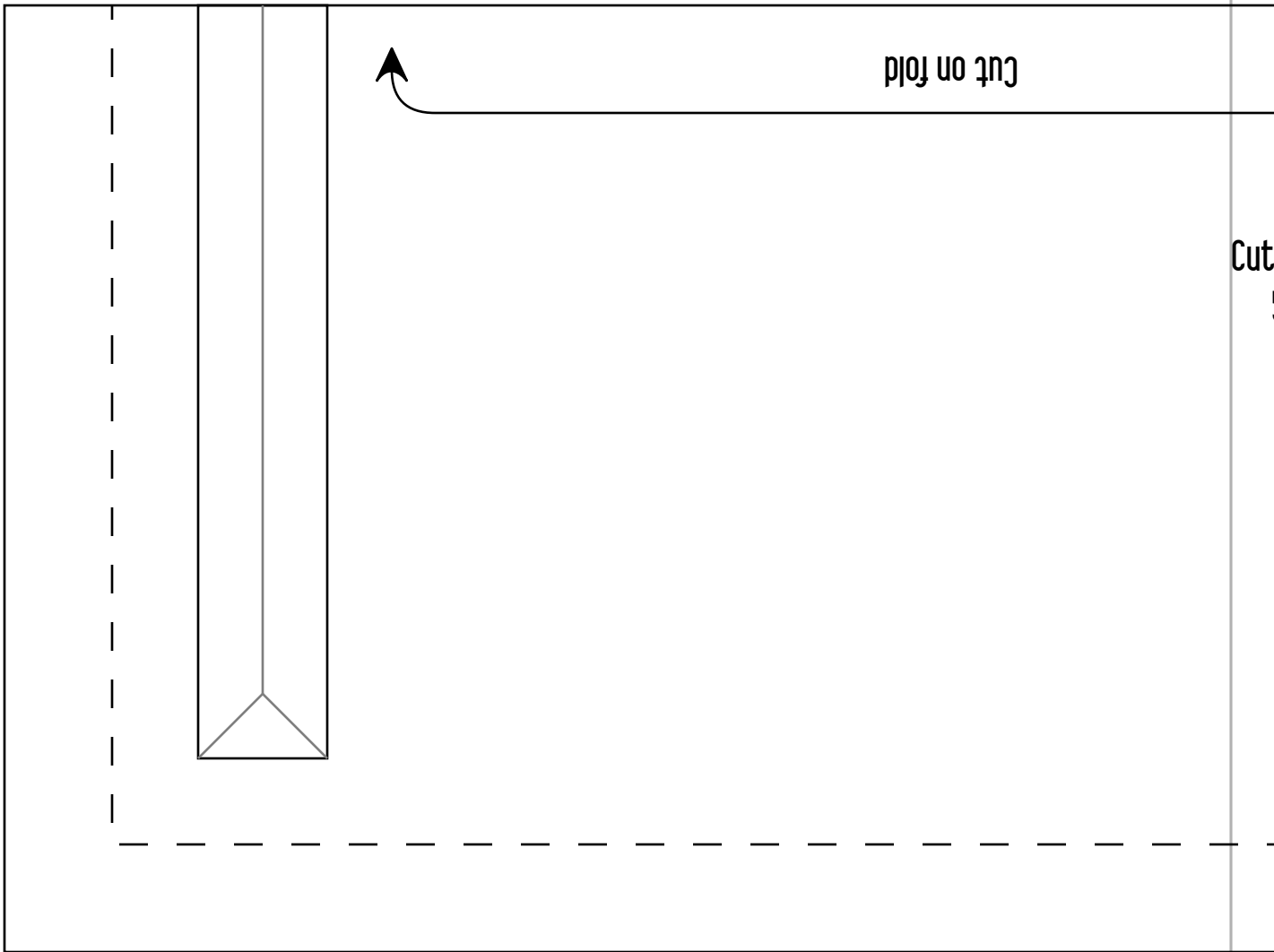

K2

L1

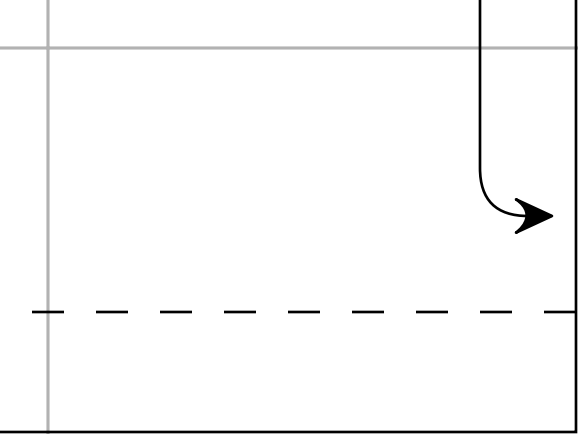

Pocket

Cut 2 on fold of lining fabric
5/8" seam allowance

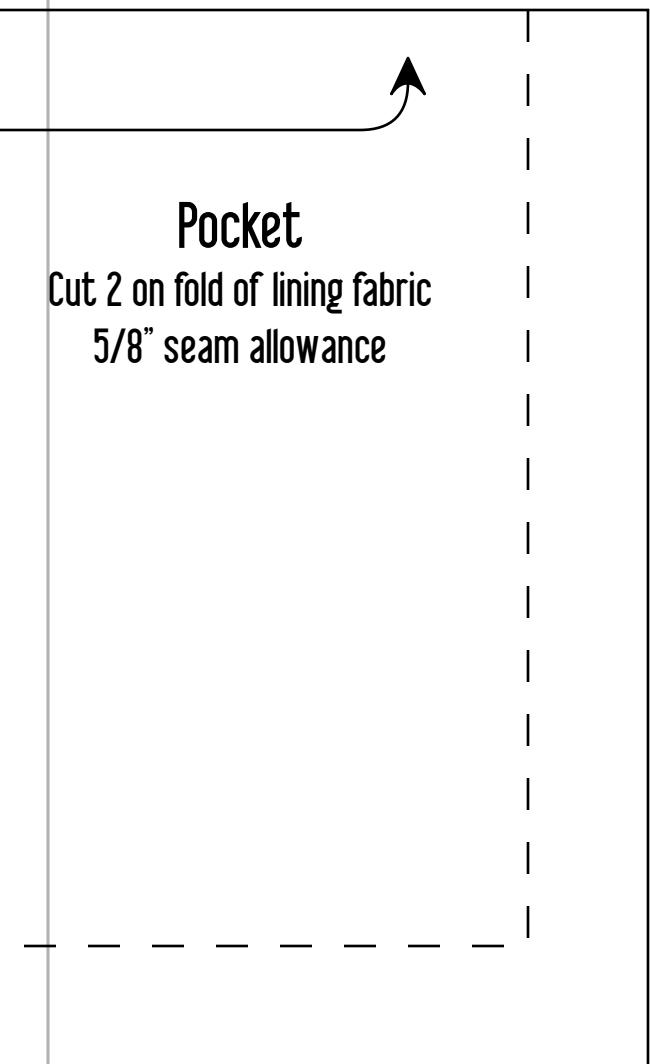

Straps

Cut 2 of contrast fabric
5/8" seam allowance

